

Crearplast

2006

Sifones sencillos

Sifones dobles

Kit desagüe cocina



SIFONES Y DESAGÜES





Creaplast

Ø	A	CÓDIGO	€/UD ***	UND	A
---	---	--------	----------	-----	---



C-1	1 ¼ 32	225 ↓ 155	010104		50	5
	1 ½ 40	235 ↓ 165	010102		50	4

Sifón botella extensible salida horizontal con válvula fregadero



C-2	1 ¼ 32	213 ↓ 150	010204		50	5
	1 ½ 40	214 ↓ 160	010202		50	5

Sifón botella extensible salida horizontal con racord (tuerca loca)



C-3	1 ¼ 32	131	010304		50	5
	1 ½ 40	141	010302		50	5

Sifón botella salida horizontal para instalar con tubos lisos



C-4	1 ¼ 32	225 ↓ 155	010404		50	5
	1 ½ 40	235 ↓ 165	010402		50	4

Sifón botella extensible salida horizontal con válvula lavabo-bidet

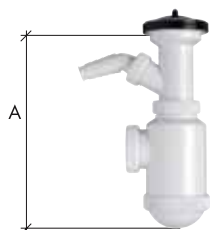

C-35	1 ½ - 40 inox - 70	265 ↓ 215	013502		50	1
	1 ½ - 40 inox - 115	265 ↓ 215	013503		50	1

Sifón botella extensible salida horizontal con toma lavadora

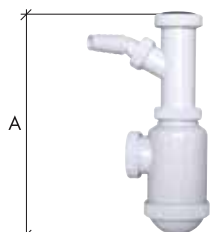

C-5	1 ½ 40	265 ↓ 215	010502		50	4
-----	-----------	-----------------	--------	--	----	---

Sifón botella extensible salida horizontal con racord y toma de electrodomésticos (tuerca loca)

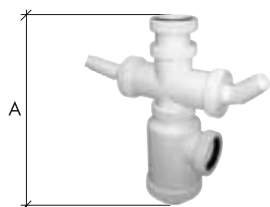

C-6	1 ½ 40	354 ↓ 284	010602		50	1
-----	-----------	-----------------	--------	--	----	---

Sifón botella extensible salida horizontal con racord y doble toma de electrodomésticos



Creaplast

Ø	A	CÓDIGO	€/UD ***	UND	A
---	---	--------	----------	-----	---



C-36	1 ½	370	013602		45	1
	40	↓ 320				
Sifón botella extensible con válvula y doble toma electrodomésticos						

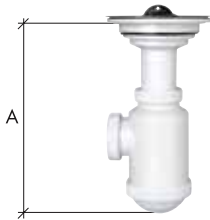

C-7	1 ½	235	010702		50	1
	40	↓ 165				
Sifón botella extensible salida horizontal con válvula fregadero de 115 Ø mm.						

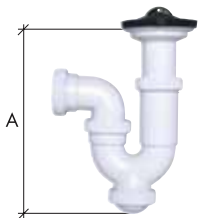

C-8	1 ¼	230	010804		50	5
	32	↓ 175				
	1 ½	250	010802		50	4
	40	↓ 185				
Sifón curvo extensible salida horizontal con válvula fregadero						



C-9	1 ¼	217	010904		50	5
	32	↓ 163				
	1 ½	230	010902		50	4
	40	↓ 169				
Sifón curvo extensible salida horizontal con racord (tuerca loca)						



C-10	1 ½	160	011002		50	5
	40					
Sifón curvo salida horizontal para instalar con tubos lisos						



C-11	1 ¼	230	011104		50	5
	32	↓ 175				
	1 ½	250	011102		50	4
	40	↓ 185				
Sifón curvo extensible salida horizontal con válvula lavabo, bidet						



C-12	1 ½	280	011202		50	4
	40	↓ 225				
Sifón curvo extensible salida horizontal con racord y toma electrodomésticos (tuerca loca)						



Creaplast

Ø	A	CÓDIGO	€/UD ***	UND	A
---	---	--------	----------	-----	---



C-37	1 ½ - 40 inox. 70	280 ↓ 225	013702		50	1
	1 ½ - 40 inox. 115	280 ↓ 225	013704		50	1,5

Sifón curvo extensible con salida horizontal con válvula y toma de electrodomésticos

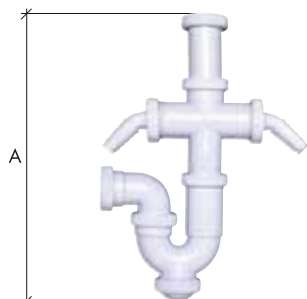

C-13	1 ½ 40	357 ↓ 298	011302		50	1,5
------	-----------	-----------------	--------	--	----	-----

Sifón curvo extensible salida horizontal con racord y doble toma de electrodomésticos (tuerca loca)



C-14	1 ½ 40	230 ↓ 175	011402		50	1
------	-----------	-----------------	--------	--	----	---

Sifón curvo extensible salida horizontal con válvula fregadero de 115 Ø mm



C-15	1 ¼ 32	120	011504		50	5
	1 ½ 40	120	011502		50	5

Sifón "y" compacto salida vertical con válvula lavabo, bidet



C-33	(*) 1 ¼ 40	115	013304		50	5
	1 ½ 40	115	013302		50	5

Sifón "y" compacto salida vertical con tuerca loca. (*) Para válvula automática

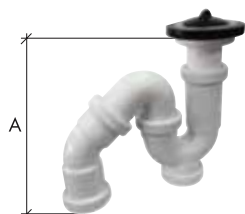

C-16	1 ½ 40	250 ↓ 185	011602		50	1
------	-----------	-----------------	--------	--	----	---

Sifón curvo extensible salida vertical, horizontal e inclinada con válvula fregadero



C-17	1 ½ 40	230 ↓ 169	011702		50	1
------	-----------	-----------------	--------	--	----	---

Sifón curvo extensible salida vertical, horizontal e inclinada con racord (tuerca loca)



Ø	A	CÓDIGO	€/UD ***	UND	A
---	---	--------	----------	-----	---



C-18	1/2	250	011802	50	4
	40	↓ 185			
Sifón curvo extensible salida inclinada con válvula lavabo y bidet					



C-19	1/2	230	011902	50	4
	40	↓ 169			
Sifón curvo extensible salida inclinada con racord (tuerca loca)					

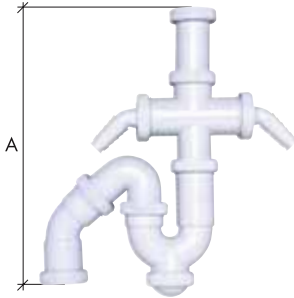

C-20	1 1/2	355	012002	50	1,5
	40	↓ 300			
Sifón curvo extensible salida vertical, horizontal e inclinada con racord y doble toma de electrodomésticos (tuerca loca)					



C-21	1 1/2	280	012102	50	1
	40	↓ 225			
Sifón curvo extensible salida vertical, horizontal e inclinada con racord y toma de electrodomésticos					



C-22	1 1/4	203	012204	50	5
	32	↓ 135			
	1 1/2	220	012202	50	5
	40	↓ 149			
Sifón botella corto extensible salida horizontal con válvula fregadero					



C-23	1 1/4	195	012304	50	5
	32	↓ 133			
	1 1/2	210	012302	50	5
	40	↓ 149			
Sifón botella corto extensible salida horizontal con racord (tuerca loca)					



C-24	1 1/4	203	012404	50	5
	32	↓ 135			
	1 1/2	220	012402	50	5
	40	↓ 149			
Sifón botella corto extensible salida horizontal con válvula lavabo, bidet					



Crearpplast



	Ø	A	CÓDIGO	€/UD ***	UND	A
C-25	1 ¼ 32	225 ↓ 155	012504		50	5
	1 ½ 40	235 ↓ 165	012502		50	4

Sifón botella extensible salida inclinada con válvula fregadero



C-26	1 ¼ 32	213 ↓ 150	012604		50	5
	1 ½ 40	214 ↓ 160	012602		50	4

Sifón botella extensible salida inclinada, con racord y tuerca loca



C-27	1 ¼ 32	225 ↓ 155	012704		50	5
	1 ½ 40	235 ↓ 165	012702		50	4

Sifón botella extensible salida inclinada con válvula lavabo, bidet

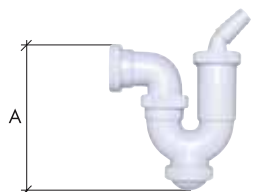

C-28	1 ½ 40	160	012802		50	5
------	-----------	-----	--------	--	----	---

Sifón curvo salida horizontal con toma para lavadora



C-29	1 ¼ 1 ½	202 ↓ 140	012902		50	5
------	------------	-----------------	--------	--	----	---

Sifón botella corto con racord, entrada 1 1/4 salida 1 1/2 especial para válvulas automáticas (tuerca loca)



C-30	1 ¼ 1 ½	122	013002		50	5
------	------------	-----	--------	--	----	---

Sifón botella corto entrada 32 Ø salida 40 Ø para válvula automática (tuerca loca)



C-31	1 ¼ 32	195 ↓ 133	013104		50	1
	1 ½ 40	220 ↓ 149	013102		50	1

Sifón botella corto extensible salida horizontal con tubo PVC blanco de encolar y plafón (tuerca loca)



Creaplast

Ø	A	CÓDIGO	€/UD ***	UND	A
---	---	--------	----------	-----	---



C-32	1 ¼ 32	203 ↓ 135	013204		50	1
	1 ½ 40	220 ↓ 165	013202		50	1

Sifón botella corto extensible con válvula salida horizontal con tubo PVC blanco de encolar y plafón



C-38	1 ½ 40	280 ↓ 195	013802		25	5
------	-----------	-----------------	--------	--	----	---

Sifón botella corto extensible con adaptador de urinario

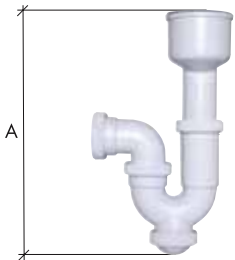

C-39	1 ½ 40	320 ↓ 230	013902		25	5
------	-----------	-----------------	--------	--	----	---

Sifón curvo extensible con adaptador de urinario



C-34	40	600 a 950	013402		25	7
------	----	-----------------	--------	--	----	---

Sifón toma de lavadora empotrar con salida de PVC encolar 40 Ø. Con embellecedor de acero inoxidable

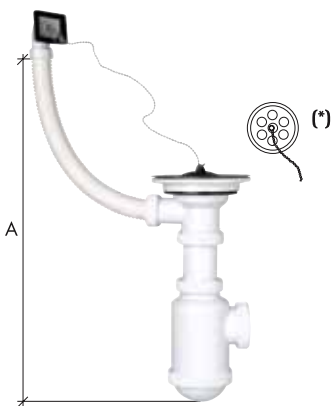

C-281	1 ½ - 40 inox. 70		012812		25	4
	1 ½ - 40 inox. 115		012813		25	4

Sifón botella con válvula extensible y rebosadero

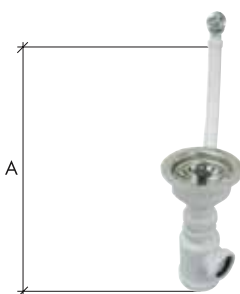

C-282	1 ½ - 40 inox. 85		012822		25	4
	1 ½ - 40 inox. 113		012823		25	4

Sifón botella extensible con válvula cestilla y rebosadero

(*) Bajo pedido se pueden suministrar con chapa de rebosadero de Ø 35 mm en acero inoxidable. (Precio 0,76 €)



Sifones Dobles

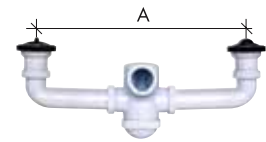

	Ø	A	CÓDIGO	€/UD ***	UND	A
C-70	1 ½ 40	450 ↓ 385	027012		25	1
Sifón botella extensible salida horizontal con doble válvula						

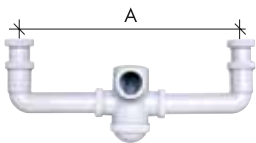

C-71	1 ½ 40	450 ↓ 395	027112		25	1
Sifón botella extensible salida horizontal con doble racord (tuerca loca)						

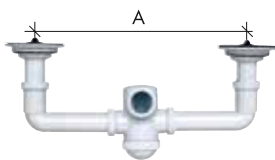

C-72	1 ½ 40	450 ↓ 395	027212		25	1
Sifón botella extensible salida horizontal con doble válvula 115 mm.						

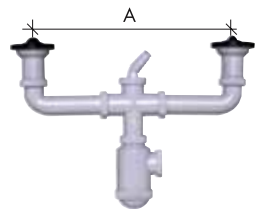

C-40	1 ½ 40	450 ↓ 385	024012		25	1,5
Sifón botella extensible salida horizontal con doble válvula y toma de electrodomésticos						

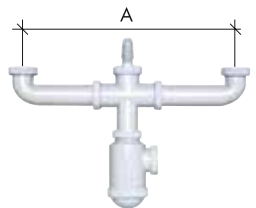

C-41	1 ½ 40	450 ↓ 385	024112		25	1
Sifón botella extensible salida horizontal con doble entrada para instalar con tubos roscados y toma de electrodomésticos (tuercas locas)						

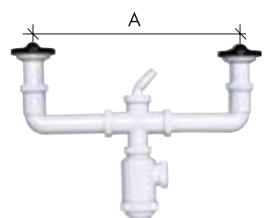

C-42	1 ½ 40	450 ↓ 395	024212		25	1,5
Sifón botella extensible salida horizontal con doble válvula extensible y toma de electrodomésticos						

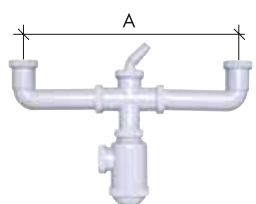

C-43	1 ½ 40	450 ↓ 395	024312		25	1
Sifón botella extensible salida horizontal con doble entrada para instalar tubos lisos y toma de electrodomésticos						

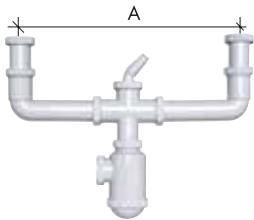

	Ø	A	CÓDIGO	€/UD ***	UND	A
C-44	1 ½ 40	450 ↓ 395	024412		25	1,5
Sifón botella salida horizontal con doble racord (extensible) y toma de electrodomésticos (tuercas locas)						

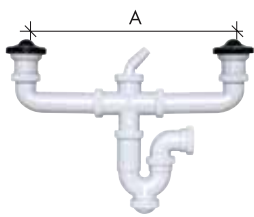

C-45	1 ½ 40	450 ↓ 385	024512		25	1,5
Sifón curvo extensible salida horizontal con doble válvula y toma de electrodomésticos						

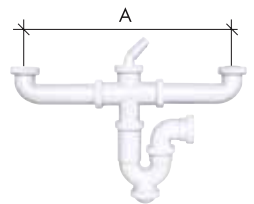

C-46	1 ½ 40	450 ↓ 385	024612		25	1
Sifón curvo extensible salida horizontal con doble entrada para instalar con tubos roscados y toma de electrodomésticos (tuercas locas)						

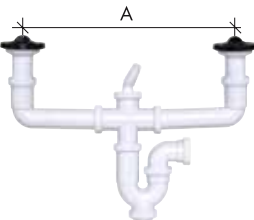

C-47	1 ½ 40	450 ↓ 395	024712		25	1,5
Sifón curvo extensible salida horizontal con doble válvula (extensible) y toma de electrodomésticos						

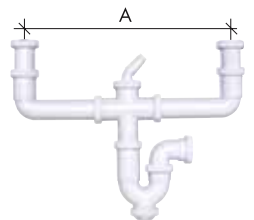

C-48	1 ½ 40	450 ↓ 395	024812		25	1,5
Sifón curvo extensible salida horizontal con doble racord (extensible) y toma de electrodomésticos (tuercas locas)						

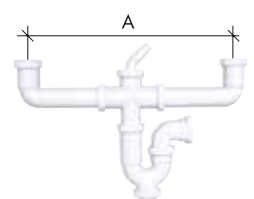

C-49	1 ½ 40	450 ↓ 395	024912		25	1
Sifón curvo extensible salida horizontal con doble entrada para instalar con tubos lisos y toma de electrodomésticos						



Sifones Dobles

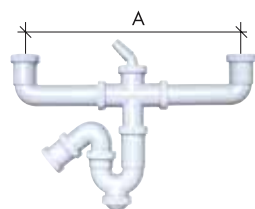

	Ø	A	CÓDIGO	€/UD ***	UND	A
C-50	1 ½ 40	450 ↓ 385	025012		25	1

Sifón curvo extensible salida inclinada con doble entrada para instalar con tubos roscados y toma de electrodomésticos (tuercas locas)

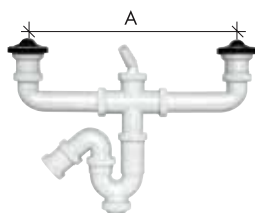

C-51	1 ½ 40	450 ↓ 385	025112		25	1
------	-----------	-----------------	--------	--	----	---

Sifón curvo extensible salida inclinada con doble válvula y toma de electrodomésticos

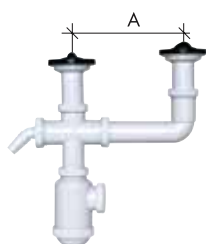

C-52	1 ½ 40	225 ↓ 197	025212		25	1
------	-----------	-----------------	--------	--	----	---

Sifón botella lateral extensible salida horizontal con doble válvula y toma de electrodomésticos

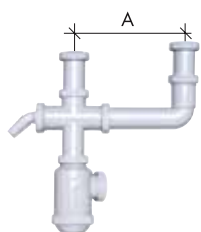

C-53	1 ½ 40	225 ↓ 197	025312		25	1
------	-----------	-----------------	--------	--	----	---

Sifón botella lateral extensible salida horizontal con doble racord y toma de electrodomésticos (tuerca loca)

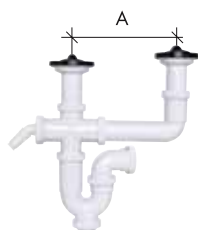

C-54	1 ½ 40	225 ↓ 385	025412		25	1
------	-----------	-----------------	--------	--	----	---

Sifón curvo lateral extensible salida horizontal con doble válvula y toma de electrodomésticos

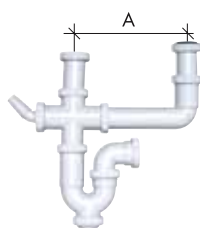

C-55	1 ½ 40	225 ↓ 385	025512		25	1
------	-----------	-----------------	--------	--	----	---

Sifón curvo lateral extensible salida horizontal con doble racord y toma de electrodomésticos (tuercas locas)



Ø	A	CÓDIGO	€/UD ***	UND	A
---	---	--------	----------	-----	---

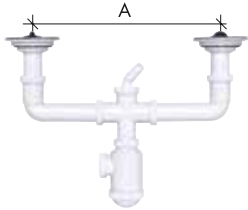

C-56	1 ½	450	025612		25	1,5
	40	↓ 395				
Sifón botella extensible salida horizontal con doble válvula 115 Ø mm y toma de electrodomésticos						

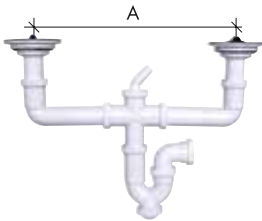

C-57	1 ½	450	025712		25	1,5
	40	↓ 395				
Sifón curvo extensible salida horizontal con doble válvula 115 Ø mm y toma de electrodomésticos						

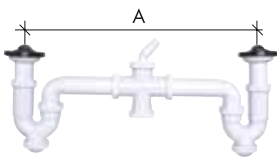

C-58	1 ½	535	025812		25	1,5
	40	↓ 310				
Sifón curvo doble con válvulas extensibles orientables y toma de electrodomésticos						

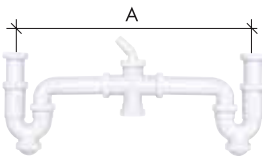

C-59	1 ½	535	025912		25	1,5
	40	↓ 310				
Sifón curvo doble con racords extensibles orientables y toma de electrodomésticos (tuercas locas)						

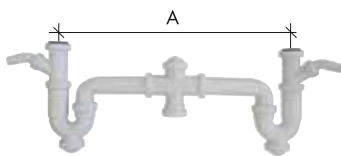

C-60	1 ½	535	026012		25	1,5
	40	↓ 310				
Sifón curvo doble con racords extensibles orientables y dos tomas de electrodomésticos (tuercas locas)						

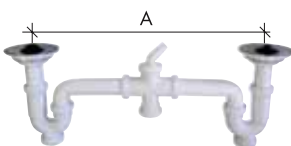

C-61	1 ½	535	026112		25	1,5
	40	↓ 310				
Sifón curvo doble con válvulas extensibles 115 Ø mm orientables y toma de electrodomésticos						



Sifones Dobles

Crearpplast

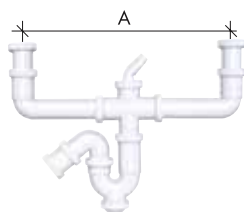

	Ø	A	CÓDIGO	€/UD ***	UND	A
C-62	1 ½	450	026212		25	1
	40	↓ 395				
Sifón curvo extensible salida inclinada con doble racord (extensible) y toma de electrodomésticos (tuercas locas)						

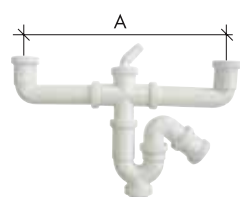

C-63	1 ½	450	026312		25	1
	40	↓ 395				
Sifón curvo extensible salida inclinada con doble entrada para instalar con tubos lisos y toma de electrodomésticos						



C-64	1 ½	225	026412		25	1
	40	↓ 197				
Sifón curvo con válvula libre espacio						



C-65	1 ½	225	026512		25	1
	40	↓ 197				
Sifón curvo con racord libre espacio						

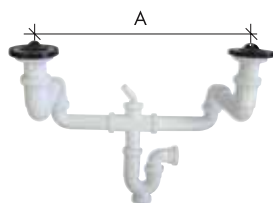

C-66	1 ½	425	026612		10	4
	40	↓ 380				
Sifón doble con válvula libre espacio						

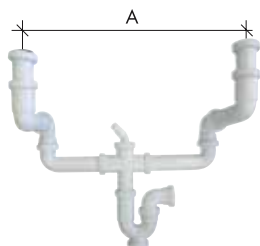

C-67	1 ½	425	026712		10	4
	40	↓ 380				
Sifón doble con racord libre espacio						

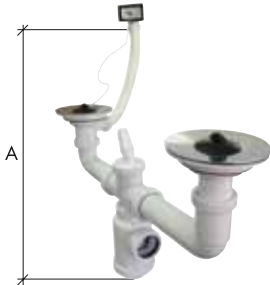

	Ø	A	CÓDIGO	€/UD***	UND	A
C-283	1 ½ - 40 inox. Ø 80	450 ↓ 395	022832		22	1,5
	1 ½ - 40 inox. Ø 115	450 ↓ 395	022833		22	1,5
Sifón doble extensible salida horizontal con doble válvula fregadero, con toma electrodomésticos y rebosadero						



C-284	inox. Ø 85	470 ↓ 415	022842		20	1,5
	inox. Ø 115	470 ↓ 415	022843		20	1,5
Sifón doble extensible salida horizontal con doble válvula cestilla de acero inoxidable con toma electrodomésticos y rebosadero						

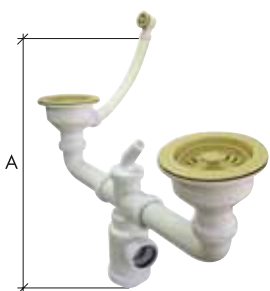

C-285	1 ½ - 40 Ø 115	470 ↓ 415	022854 BLANCO		20	1,5
	1 ½ - 40 Ø 115	470 ↓ 415	022855 MARRÓN		20	1,5
	1 ½ - 40 Ø 115	470 ↓ 415	022856 TIERRA FRANCIA		20	1,5
	1 ½ - 40 Ø 115	470 ↓ 415	022857 CHAMPAGNE		20	1,5
Sifón doble extensible salida horizontal con doble válvula cestilla de 115Ø con toma electrodomésticos y rebosadero						



Crearplast



	Ø	A	CÓDIGO	€/UD ***	UND	A
C-68	S/40	165	026812		25	4

Componentes desagüe cocina, lavadora, lavavajillas y fregadero



C-69	S/50	165	026912		25	4
------	------	-----	--------	--	----	---

Componentes desagüe cocina, lavadora, lavavajillas y fregadero



C-199	40	110	070199		25	8
-------	----	-----	--------	--	----	---

Toma electrodomésticos con codo 40-87° macho



C-269	40	110	070269		25	8
-------	----	-----	--------	--	----	---

Doble toma electrodomésticos con codo 40-87° macho

Kit

desagüe
cocina

Crearplast[®]
ISO 9000

Esquema de Instalación

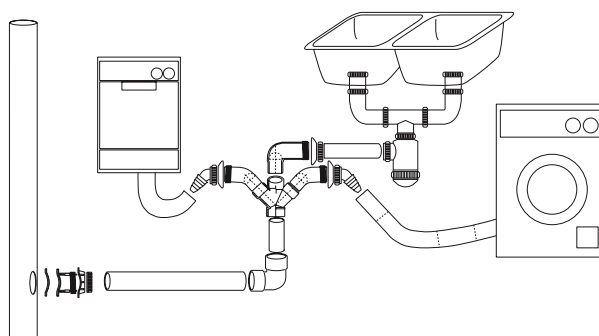

Instalación
fácil y segura

***consultar precios